

ETF-1490-FM-FA Stainless Steel Front Mounted Floor Outlet Floor Mounted Siphon Jet Series Toilet

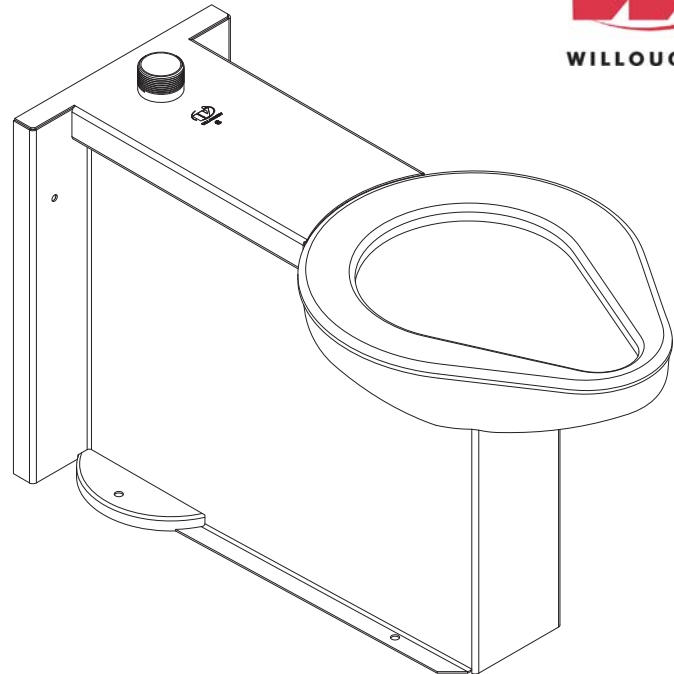

IN COMPLIANCE
WITH A.D.A. 2010

** USE "HC" SUFFIX FOR
18" A.F.F. SEAT HEIGHT



(1.6 GPF UNIT W/ 15" A.F.F.
SEAT HEIGHT* SHOWN)
(Unit may be shown with optional features)

To specify fixture and accessories, use the Model Number and Options page.

Example: To specify a Front Access, Floor Outlet, Floor Mounted Siphon Jet Series Toilet with top spud, standard 15" seat height, 1.6 GPF, standard gasketed waste connection, floor outlet waste connection, hydraulic flush valve, flush valve cover, high polish seat, and toilet shipping cover

Use the following Willoughby Model Number:
ETF-1490-FM-FA-TS-1.6-GWC-TW4-FV-FVC-HPS-TSC

Recommended Specifications

Stainless Steel, Front Mounted, Floor Outlet, Floor Mounted, Siphon Jet Series Toilet shall be: Willoughby Model No. **ETF-1490-FM-FA**
(Select from model number and options list on next page)

Fixture shall be fabricated from 14 gauge, type 304 stainless steel. The construction shall be all welded, with exposed stainless surfaces polished to a #4 satin finish.

Standard toilet shall include:

- Elongated toilet bowl with contoured seat
- Integral crevice-free self-draining flushing rim with positive afterfill
- Fully enclosed 2-3/8" O.D. trap which shall maintain a minimum 2" seal and pass a 2" ball
- Bead blast finish bowl interior

Toilet shall be siphon jet type, requiring 35 PSI minimum flushing pressure. Model shall meet the requirements of ASME A112.19.3/CSA B45.4.

Fixture shall withstand loadings of 5,000 lbs. without permanent damage.

Anchoring shall be through the front and through the floor (anchoring hardware provided by others).

Unit requires no chase area for installation and maintenance unless specified with any Toilet Waste Extension options or Toilet Overflow Preventer options.

Note: Unit will pass a 2" ball.

Note: Fixture should only be used with a listed high-efficiency flushometer to ensure the complete system meets the requirements of WaterSense.



WARNING: Cancer and Reproductive Harm

- www.P65Warnings.ca.gov

visit our website at www.willoughby-ind.com
5105 West 78th Street • Indianapolis, IN. 46268
(317) 875-0830 • Fax: (317) 875-0837 • (800) 428-4065



MADE IN THE U.S.A.

MODEL NUMBER AND OPTIONS:

1.) Base Model Number:

- ETF-1490-FM-FA Stainless Steel, Front Mounted, Floor Outlet, Floor Mounted, Siphon Jet Series Toilet

2.) Floor Outlet Rough-In:

- 4-1/4" Fixture Rough-In (Shown, Standard)
- 10" 10" Fixture Rough-In
- 12" 12" Fixture Rough-In (Changes Overall Fixture Length to 32-3/4")

3.) Inlet Location:

- BS Back Spud
- TS Top Spud

4.) Toilet Seat Height:

- 15" Seat Height (Standard)
- HC 18" Seat Height, Handicap-ADA Compliant

5.) Toilet Waste:

- GWC Gasketed Waste Connection (Standard)
- TW4 4" Cast Iron Closet Flange

6.) Flush Valve:

- FV Hydraulic Flush Valve (Includes Actuator)
 - 1.28 GPF HET (4.8 Lpf) 1.6 GPF ULF (6.0 Lpf)
 - 3.5 GPF (13.2 Lpf)***
- EFVP Electronic Flush Valve w/ (PZPB) Ligature-resistant Piezo Push Button (Pick Control)**
 - 1.28 GPF HET (4.8 Lpf) 1.6 GPF ULF (6.0 Lpf)
 - 3.5 GPF (13.2 Lpf)***
- RFVB Remote Flush Valve with Box
 - 1.28 GPF HET (4.8 Lpf) 1.6 GPF ULF (6.0 Lpf)
 - 3.5 GPF (13.2 Lpf)***
- REFVB Remote Electronic Flush Valve with Box*
 - 1.28 GPF HET (4.8 Lpf) 1.6 GPF ULF (6.0 Lpf)
 - 3.5 GPF (13.2 Lpf)***
- NFV No Flush Valve (Provided by Others)

7.) Other Options:

- T4 Manual Reset Toilet Overflow Preventer, Requires: (FV) Hydraulic Flush Valve and Accessible Chase
- ET4 Electronic Toilet Overflow Preventer*, Requires (EFVP), Accessible Chase, & (WUCC-3010) or (WMSII) control Flush Valve Connection (Back Spud Only)
- FVT Flush Valve Cover (Ligature-resistant, Top Spud Only)**
- ASFVCADA Ligature-resistant ADA Flush Valve Cover (Top Spud Only)**
- AP Flush Valve Access Panel (Allows access to chase mounted flush valve from fixture side)
- HS Hinged White Plastic Seat (No Cover, not recommended for Maximum Security/Ligature-resistant use)
- DC Decorator Color (Fixture exterior only - White)
- TF24H Hard-wired Transformer, 110VAC to 24VAC*
- TF24P Plug-in Transformer, 110VAC to 24VAC*
- HPS High Polish Seat
- MT Wall Template
- TSC Toilet Shipping Cover
- RTH1 Wall Mounted Recessed Tissue Holder (Rear Mounted, Requires Accessible Chase)
- RTH2 Wall Mounted Recessed Tissue Holder (Front Mounted, 4-1/2" Depth)
- Other _____
- Other _____

8.) Electronic Controls* (Must Use Electronic Flush Valve):

- WUFC-4000 Pneumatic WMSII
- WUCC-3010 (Select WUCC-3010 Control if pairing a Toilet with a Lavatory or if the Toilet is selected with an (ET4) overflow option)

*(Req. 110V power through ground fault interrupter (GFCI) receptacle / breaker)

**LIGATURE-RESISTANT DISCLAIMER

This product is designed to minimize ligature points. While every effort has been made to reduce the possibility of ligature points, this product does not eliminate all risks. Ligature-Resistant products by Willoughby Industries are to be used in conjunction with, not as a replacement for, trained professionals.

***For replacement fixtures only

Approved For Manufacturing By: _____ Date: _____ Company: _____
 Wall Thickness: _____ Wall Type: _____

VERIFY ALL DIMENSIONS WITH FACTORY PRIOR TO ROUGH-IN
 WILLOUGHBY RESERVES THE RIGHT TO MAKE CHANGES IN DESIGN AND DIMENSIONS WITHOUT FORMAL NOTICE AND WITHOUT INCURRING OBLIGATION.

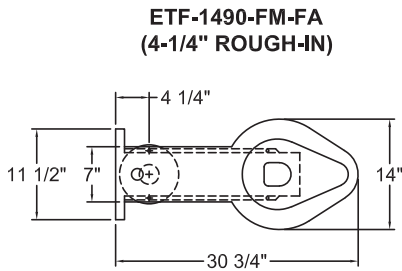

PLAN VIEW

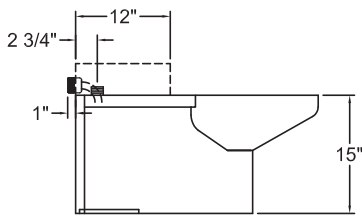

SIDE VIEW

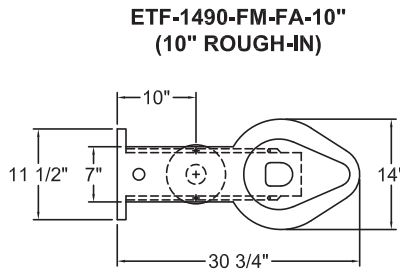

PLAN VIEW

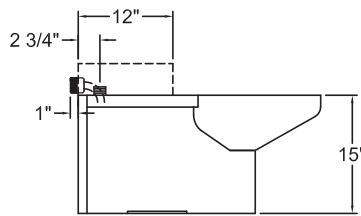

SIDE VIEW

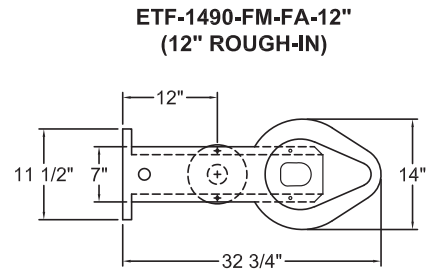

PLAN VIEW

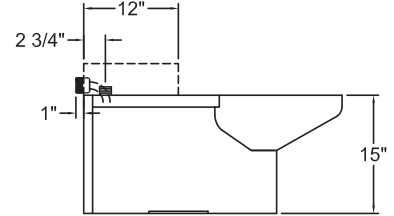

SIDE VIEW

visit our website at www.willoughby-ind.com
 5105 West 78th Street • Indianapolis, IN. 46268
 (317) 875-0830 • Fax: (317) 875-0837 • (800) 428-4065



MADE IN THE U.S.A.