

TOILET WASTE LOCATION

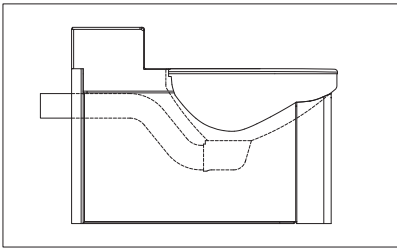

(ETW)- WALL OUTLET, BLOWOUT

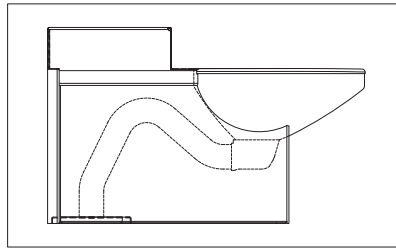

(ETF)- FLOOR OUTLET, SIPHON JET

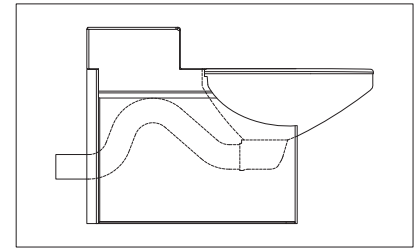

(ETWS)- WALL OUTLET, SIPHON JET

FIXTURE MOUNTING

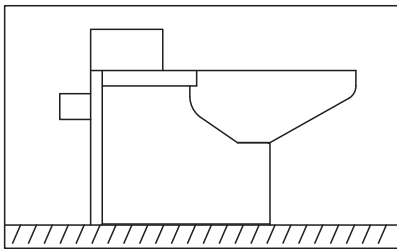

(FM)- FLOOR MOUNTED

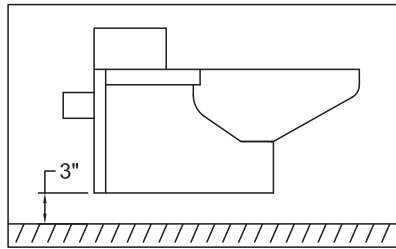

(OF)- OFF FLOOR MOUNTED

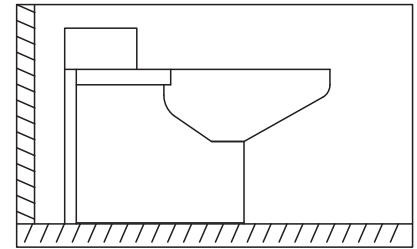

(OW)- OFF WALL MOUNTED

INLET LOCATION

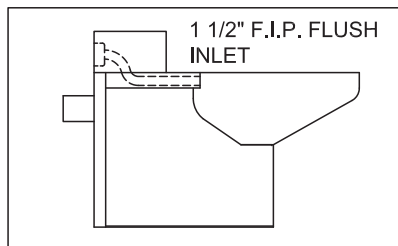

(BS)- BACK SPUD

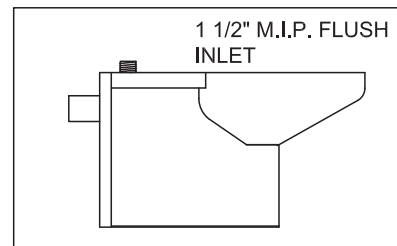

(TS)- TOP SPUD



WILLOUGHBY

TOILET WASTE OPTIONS

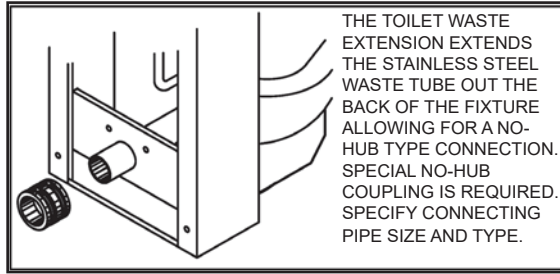

(TWE)- TOILET WASTE EXTENSION

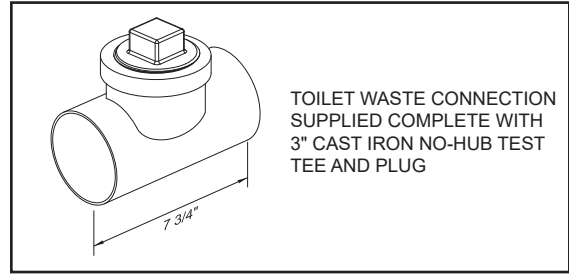

(TW3)- NO-HUB WASTE W/ 3" CLEAN-OUT



(TW4) FLOOR OUTLET WASTE CONNECTION

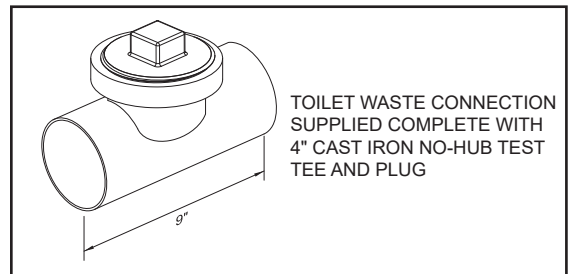

(TW5)- NO-HUB WASTE W/ 4" CLEAN-OUT

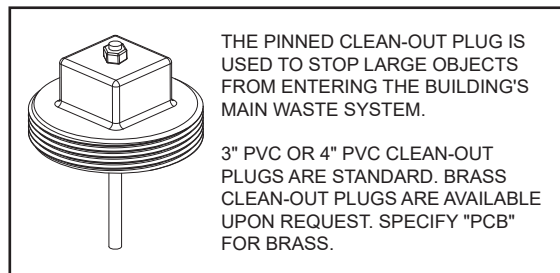

(PC_) - PINNED CLEAN-OUT PLUG

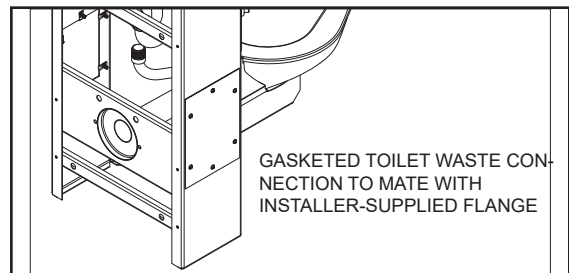

(GWC)- GASKETED WASTE CONNECTION
(Stainless Steel SHOWN)

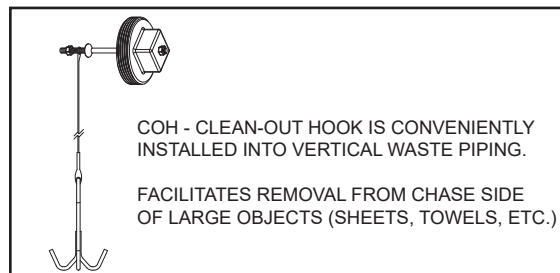

(COH4) CLEAN-OUT HOOK

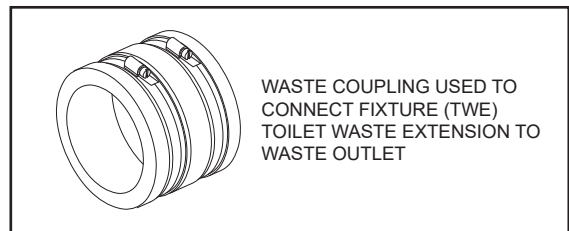

(TWC_) - TOILET WASTE COUPLING

visit our website at www.willoughby-ind.com

5105 West 78th Street • Indianapolis, IN. 46268

(317) 875-0830 • Fax: (317) 875-0837 • (800) 428-4065



MADE IN THE U.S.A.

OPTIONS

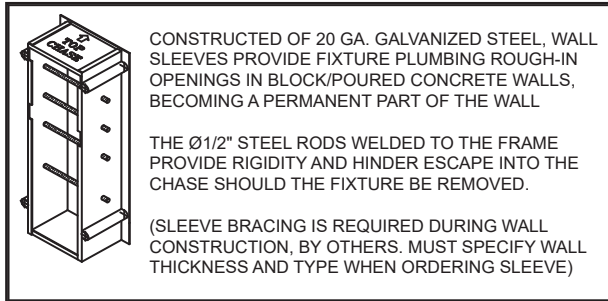

CONSTRUCTED OF 20 GA. GALVANIZED STEEL, WALL SLEEVES PROVIDE FIXTURE PLUMBING ROUGH-IN OPENINGS IN BLOCK/POURED CONCRETE WALLS, BECOMING A PERMANENT PART OF THE WALL

THE Ø1/2" STEEL RODS WELDED TO THE FRAME PROVIDE RIGIDITY AND HINDER ESCAPE INTO THE CHASE SHOULD THE FIXTURE BE REMOVED.

(SLEEVE BRACING IS REQUIRED DURING WALL CONSTRUCTION, BY OTHERS. MUST SPECIFY WALL THICKNESS AND TYPE WHEN ORDERING SLEEVE)

(WS)- WALL SLEEVE

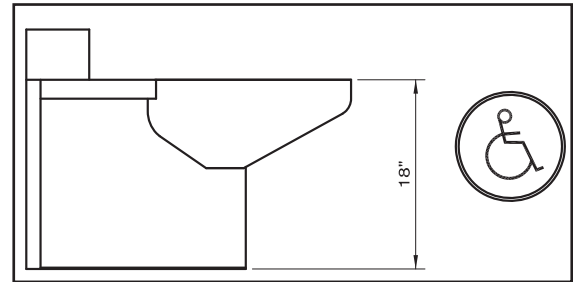

(HC)- 18" ADA-COMPLIANT HANDICAP SEAT HEIGHT

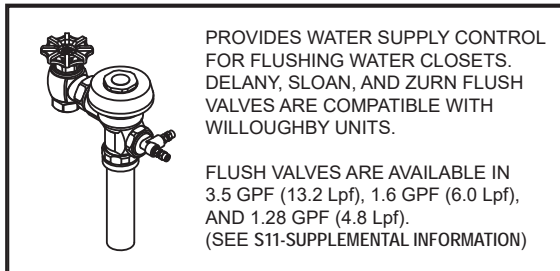

PROVIDES WATER SUPPLY CONTROL FOR FLUSHING WATER CLOSETS. DELANY, SLOAN, AND ZURN FLUSH VALVES ARE COMPATIBLE WITH WILLOUGHBY UNITS.

FLUSH VALVES ARE AVAILABLE IN 3.5 GPF (13.2 Lpf), 1.6 GPF (6.0 Lpf), AND 1.28 GPF (4.8 Lpf). (SEE S11-SUPPLEMENTAL INFORMATION)

(FV)- HYDRAULIC FLUSH VALVE
(INCLUDES ACTUATOR)

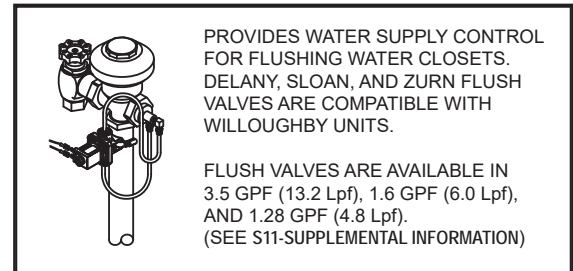

PROVIDES WATER SUPPLY CONTROL FOR FLUSHING WATER CLOSETS. DELANY, SLOAN, AND ZURN FLUSH VALVES ARE COMPATIBLE WITH WILLOUGHBY UNITS.

FLUSH VALVES ARE AVAILABLE IN 3.5 GPF (13.2 Lpf), 1.6 GPF (6.0 Lpf), AND 1.28 GPF (4.8 Lpf). (SEE S11-SUPPLEMENTAL INFORMATION)

(EFVP)- ELECTRONIC FLUSH VALVE w/ (PZPB)
(FOR USE W/ WILLOUGHBY ELECTRONIC CONTROLS)

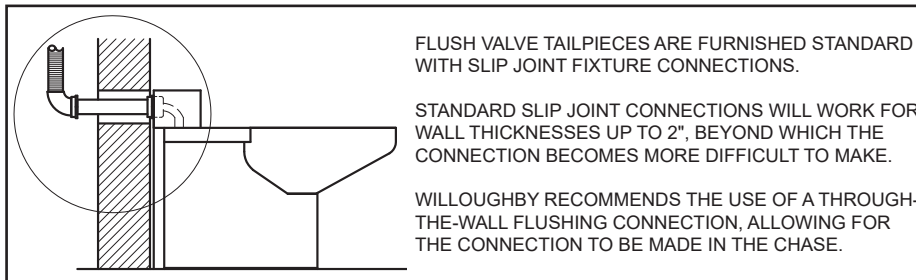

FLUSH VALVE TAILPIECES ARE FURNISHED STANDARD WITH SLIP JOINT FIXTURE CONNECTIONS.

STANDARD SLIP JOINT CONNECTIONS WILL WORK FOR WALL THICKNESSES UP TO 2", BEYOND WHICH THE CONNECTION BECOMES MORE DIFFICULT TO MAKE.

WILLOUGHBY RECOMMENDS THE USE OF A THROUGH-THE-WALL FLUSHING CONNECTION, ALLOWING FOR THE CONNECTION TO BE MADE IN THE CHASE.

(FVT)- FLUSH VALVE THROUGH WALL CONNECTION

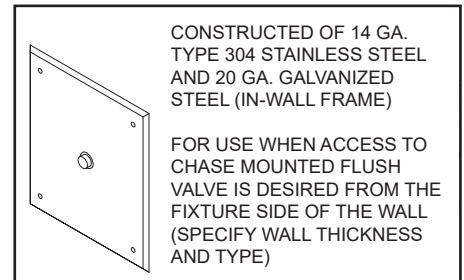

CONSTRUCTED OF 14 GA. TYPE 304 STAINLESS STEEL AND 20 GA. GALVANIZED STEEL (IN-WALL FRAME)

FOR USE WHEN ACCESS TO CHASE MOUNTED FLUSH VALVE IS DESIRED FROM THE FIXTURE SIDE OF THE WALL (SPECIFY WALL THICKNESS AND TYPE)

(AP)- FLUSH VALVE ACCESS PANEL

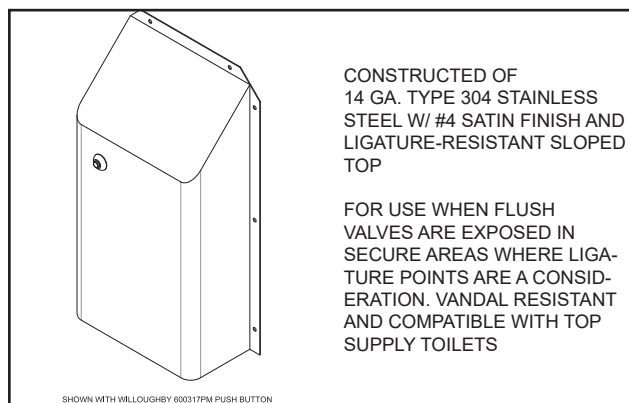

CONSTRUCTED OF 14 GA. TYPE 304 STAINLESS STEEL W/ #4 SATIN FINISH AND LIGATURE-RESISTANT SLOPED TOP

FOR USE WHEN FLUSH VALVES ARE EXPOSED IN SECURE AREAS WHERE LIGATURE POINTS ARE A CONSIDERATION. VANDAL RESISTANT AND COMPATIBLE WITH TOP SUPPLY TOILETS

SHOWN WITH WILLOUGHBY 600317PM PUSH BUTTON

(ASFVC)- LIGATURE-RESISTANT
FLUSH VALVE COVER

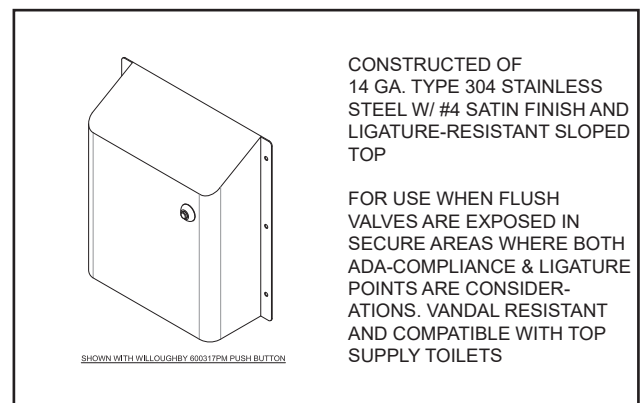

CONSTRUCTED OF 14 GA. TYPE 304 STAINLESS STEEL W/ #4 SATIN FINISH AND LIGATURE-RESISTANT SLOPED TOP

FOR USE WHEN FLUSH VALVES ARE EXPOSED IN SECURE AREAS WHERE BOTH ADA-COMPLIANCE & LIGATURE POINTS ARE CONSIDERATIONS. VANDAL RESISTANT AND COMPATIBLE WITH TOP SUPPLY TOILETS

SHOWN WITH WILLOUGHBY 600317PM PUSH BUTTON

(ASFVCADA)- LIGATURE-RESISTANT
ADA FLUSH VALVE COVER

visit our website at www.willoughby-ind.com
5105 West 78th Street • Indianapolis, IN. 46268
(317) 875-0830 • Fax: (317) 875-0837 • (800) 428-4065



MADE IN THE U.S.A.

OPTIONS (CONTINUED)



THE TOILET OVERFLOW PREVENTER IS RECOMMENDED FOR FACILITIES WITH HIGH VANDALISM. (T4) IS NORMALLY USED IN CONJUNCTION WITH A BACK SUPPLY TOILET OR COMBINATION UNIT WHERE AN ACCESSIBLE PIPE CHASE IS PROVIDED

(T4)- MANUAL RESET TOP FOUR OVERFLOW PREVENTER (REQUIRES (FV) HYDRAULIC FLUSH VALVE AND ACCESSIBLE CHASE)

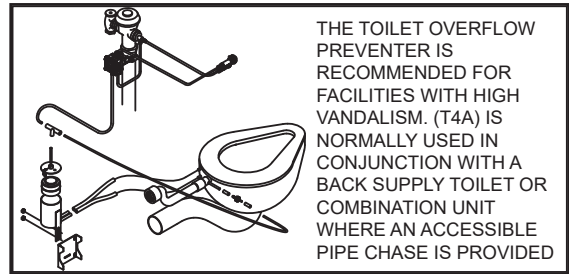

THE TOILET OVERFLOW PREVENTER IS RECOMMENDED FOR FACILITIES WITH HIGH VANDALISM. (T4A) IS NORMALLY USED IN CONJUNCTION WITH A BACK SUPPLY TOILET OR COMBINATION UNIT WHERE AN ACCESSIBLE PIPE CHASE IS PROVIDED

(T4A)- AUTO RESET TOP FOUR OVERFLOW PREVENTER (REQUIRES (FV) HYDRAULIC FLUSH VALVE AND ACCESSIBLE CHASE)

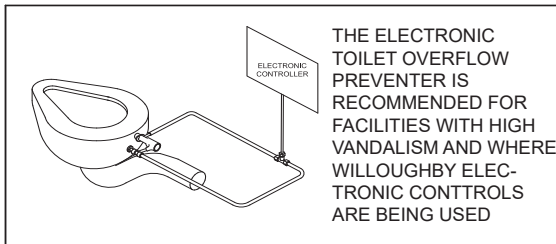

THE ELECTRONIC TOILET OVERFLOW PREVENTER IS RECOMMENDED FOR FACILITIES WITH HIGH VANDALISM AND WHERE WILLOUGHBY ELECTRONIC CONTROLS ARE BEING USED

(ET4)-ELECTRICAL TOP FOUR OVERFLOW PREVENTER (REQUIRES ELECTRONIC FLUSH VALVE)



TOILET SEAT TOP IS POLISHED TO A #7 MIRROR FINISH.

(HPS)- HIGH POLISH SEAT

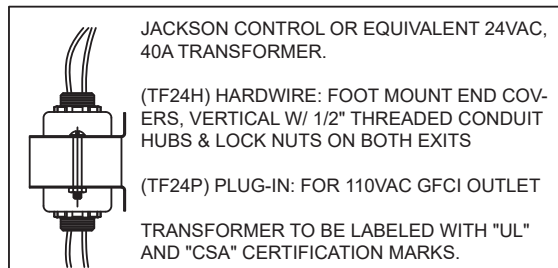

JACKSON CONTROL OR EQUIVALENT 24VAC, 40A TRANSFORMER.

(TF24H) HARDWIRE: FOOT MOUNT END COVERS, VERTICAL W/ 1/2" THREADED CONDUIT HUBS & LOCK NUTS ON BOTH EXITS

(TF24P) PLUG-IN: FOR 110VAC GFCI OUTLET

TRANSFORMER TO BE LABELED WITH "UL" AND "CSA" CERTIFICATION MARKS.

(TF24__)- TRANSFORMER, 110VAC TO 24VAC



ELONGATED PLASTIC SEAT IS OF SANITARY, OPEN FRONT DESIGN, NOT RECOMMENDED IN MAXIMUM SECURITY AREAS

(AVAILABLE IN WHITE)

(HS)- HINGED PLASTIC SEAT

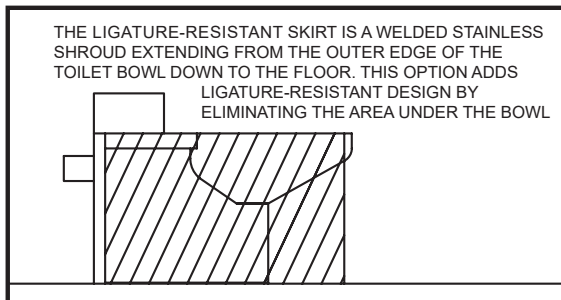

THE LIGATURE-RESISTANT SKIRT IS A WELDED STAINLESS SHROUD EXTENDING FROM THE OUTER EDGE OF THE TOILET BOWL DOWN TO THE FLOOR. THIS OPTION ADDS LIGATURE-RESISTANT DESIGN BY ELIMINATING THE AREA UNDER THE BOWL

(SK)- LIGATURE-RESISTANT TOILET SKIRT

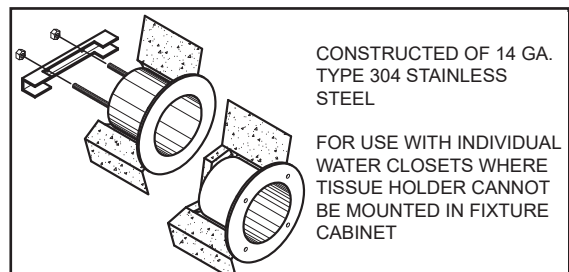

CONSTRUCTED OF 14 GA. TYPE 304 STAINLESS STEEL

FOR USE WITH INDIVIDUAL WATER CLOSETS WHERE TISSUE HOLDER CANNOT BE MOUNTED IN FIXTURE CABINET

(RTH1)- RECESSED TISSUE HOLDER (REAR MOUNT)
 (RTH2)- RECESSED TISSUE HOLDER (FRONT MOUNT)
 (ASRTH1)- LIGATURE-RESISTANT RECESSED TISSUE HOLDER (REAR MOUNT)
 (ASRTH2)- LIGATURE-RESISTANT RECESSED TISSUE HOLDER (FRONT MOUNT)
 (ASRTH3)- LIGATURE-RESISTANT STUD WALL RECESSED TISSUE HOLDER (FRONT MOUNT)

OPTIONS (CONTINUED)

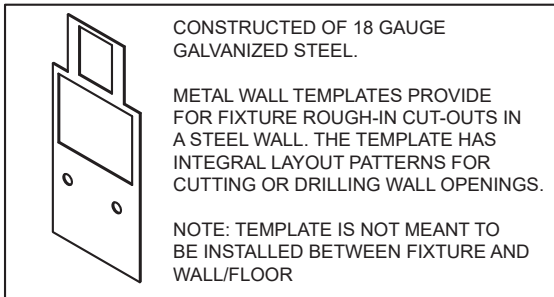

(MT)- WALL TEMPLATE

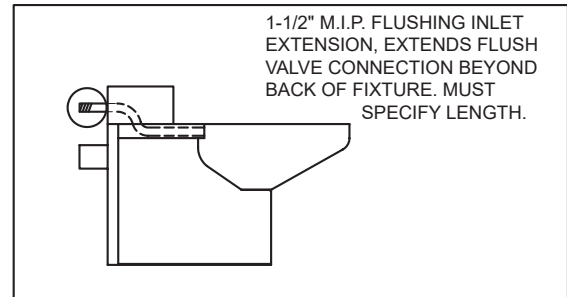

(TFE)- TOILET FLUSH EXTENSION

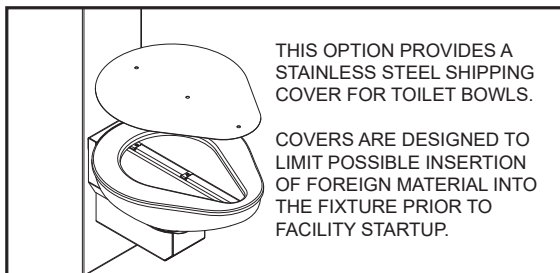

(TSC)- TOILET SHIPPING COVER