

NOTE: MOUNTING HARDWARE BY OTHERS

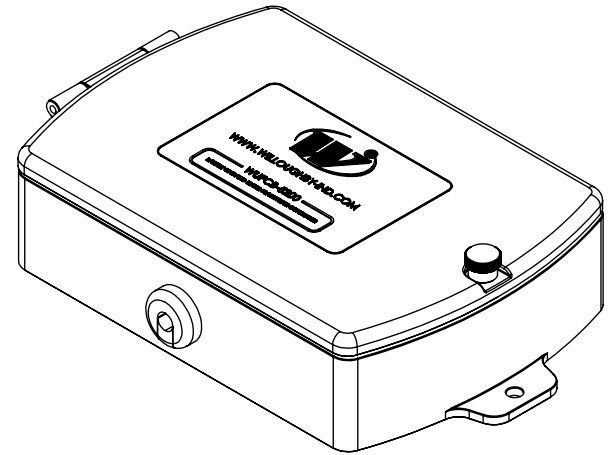
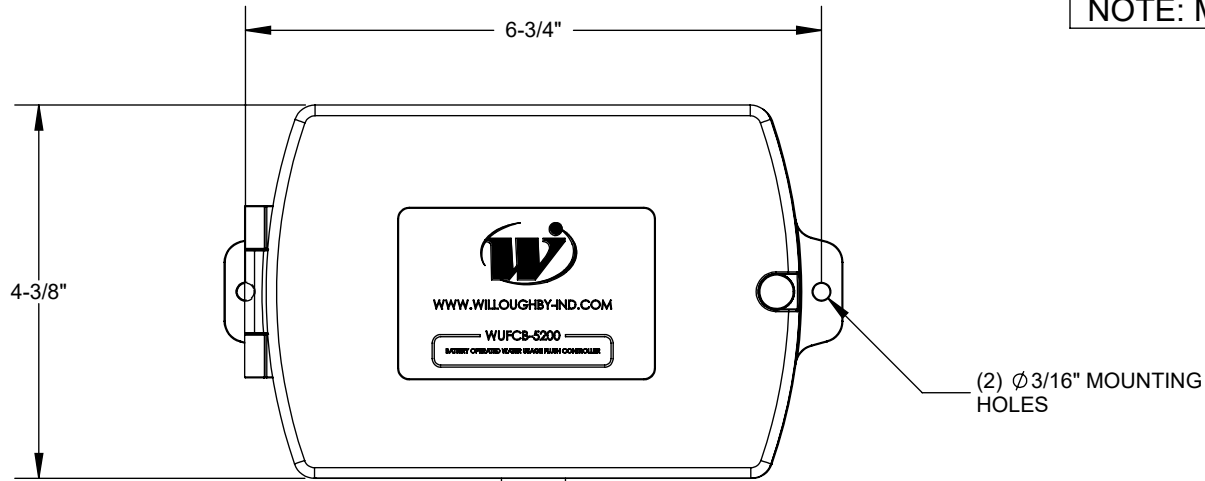

(2)  $\varnothing 3/16"$  MOUNTING HOLES

FLUSH 1 TWISTED RED & BLACK VALVE CONNECTION WIRES TO FLUSH VALVE

RED WIRE (POSITIVE)

FLUSH 2 TWISTED RED & BLACK CONNECTION WIRES TO FLUSH VALVE

BLACK WIRE (NEGATIVE)

FLUSH 1 TWISTED RED CONNECTION WIRES TO PUSH BUTTON

FLUSH 2 TWISTED RED CONNECTION WIRES TO PUSH BUTTON

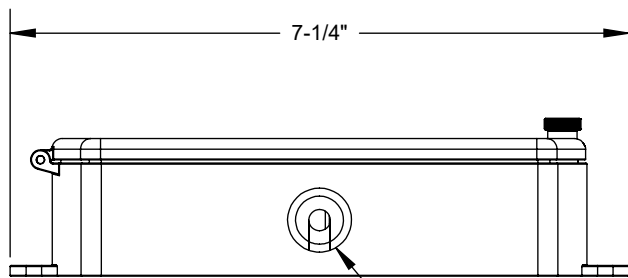

WIRING PORT

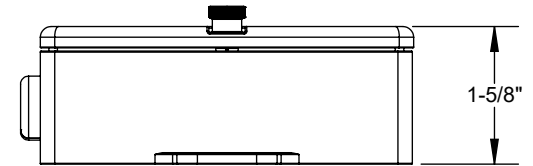

 WILLOUGHBY	<b>Willoughby Industries, Inc.</b> Indianapolis, Indiana		TITLE / DESC.: WUFCB-5200 FLUSH CONTROL ASSEMBLY, BATTERY OPERATED		PART #: 701540	
	TOLERANCES EXCEPT AS NOTED	2 PLCS: $\pm 0.03$ 3 PLCS: $\pm 0.015$ FRACTIONS: $\pm 1/4"$ ANGLE: $\pm 1^\circ$	SIZE: A	MATL: SEE BOM	REVISION: A	ORIG.: NAL 2/20/20 REV.: NAL 4/9/20

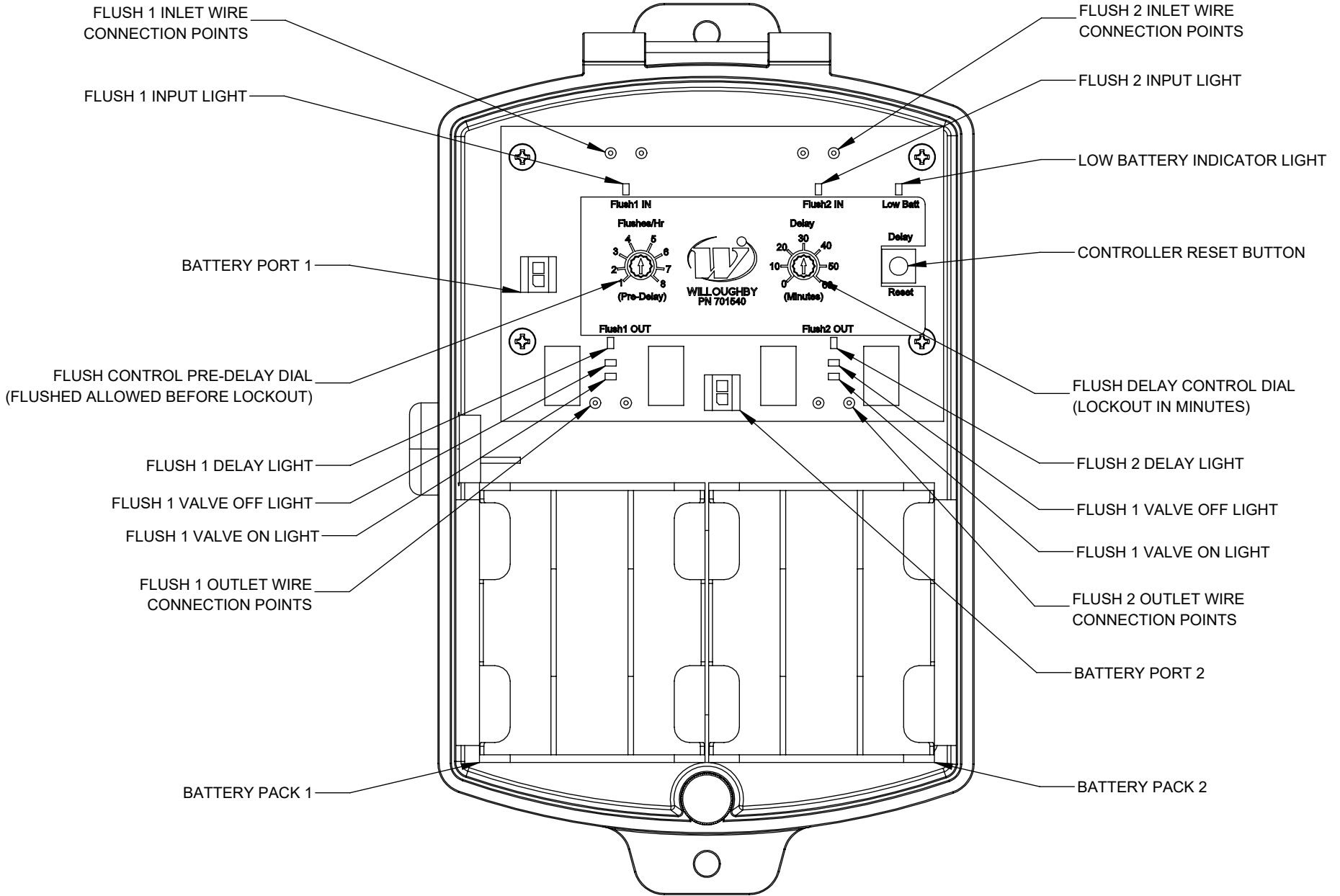

	<b>Willoughby Industries, Inc.</b> Indianapolis, Indiana		TITLE / DESC.: WUFCB-5200 FLUSH CONTROL ASSEMBLY, BATTERY OPERATED				PART #: 701540	
	TOLERANCES EXCEPT AS NOTED		2 PLCS: $\pm 0.03$ 3 PLCS: $\pm 0.015$	SIZE: A	MATL: SEE BOM		REVISION: A	ORIG.: NAL 2/20/20 REV.: NAL 4/9/20

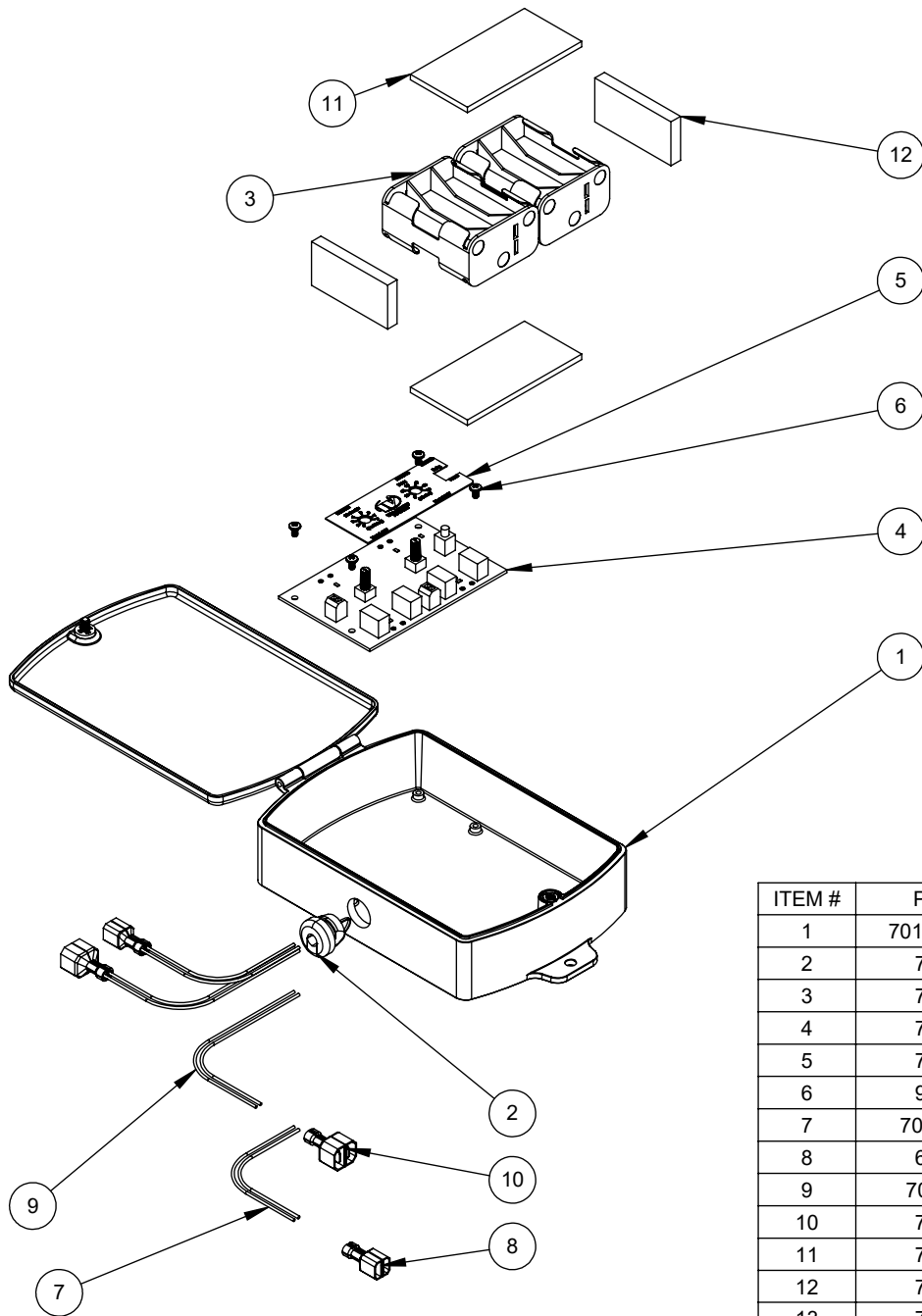

NOTE: #13, & 14 IS NOT SHOWN

ITEM #	PART #	DESCRIPTION	QTY.
1	701550A-NM	ENCLOSURE, CVC - NO MACHINING	1
2	701524	BUSHING, STRAIN RELIEF CVC2	1
3	701545	BATTERY HOLDER, FLUSH CONTROLLER	2
4	701541	PCB ASSEMBLY, BATTERY FLUSH CONTROL	1
5	701542	LABEL, WUFCB, BO FLUSH CONTROL	1
6	980716	SCREW, OVAL HEAD PHILLIPS, 4-40 THREAD, 3/16" LONG, 18-8 SS	4
7	701330-02	WIRE, 22AWG BLACK/RED TWISTED	2
8	600830	CONNECTOR, 1/4"FEM, 18-22 AWG, FI	4
9	701330-2	WIRE, 22AWG PAIR, RED, STRANDED, TWISTED	2
10	701077	CONNECTOR, 1/4" TAB, 18-22AWG, FI	4
11	701544	FOAM STRIP, 1-1/2" X 1/8" THICK	2
12	701543	FOAM STRIP, 1" X 1/4" THICK	2
13	701547	WIRE TIE LABEL	2
14	701548	DECAL, WUFCB, BO FLUSH CONTROL	1



**Willoughby Industries, Inc.**  
Indianapolis, Indiana

TOLERANCES EXCEPT AS NOTED  
2 PLCS: ±0.03  
3 PLCS: ±0.015  
FRACTIONS: ±1/4"  
ANGLE: ±1°

TITLE / DESC:

WUFCB-5200  
FLUSH CONTROL ASSEMBLY, BATTERY OPERATED

PART #:

701540

SIZE: A

MATL: SEE BOM

REVISION: A

ORIG.: NAL 2/20/20

STANDARD

REV.: NAL 4/9/20

SHEET: 3 OF 3